

SMRH₁ Series Shielded Power Inductors



FEATURES

- ROHS, Halogen free and REACH Compliance
- Magnetic shielded surface mount inductor
- High current rating, low DC resistance

APPLICATIONS

- AP Routers, STBs and LCD TVs.
- Monitors, Game consoles and LED lightings
- Notebook computer, DC - DC converters, etc

SHAPE AND DIMENSIONS

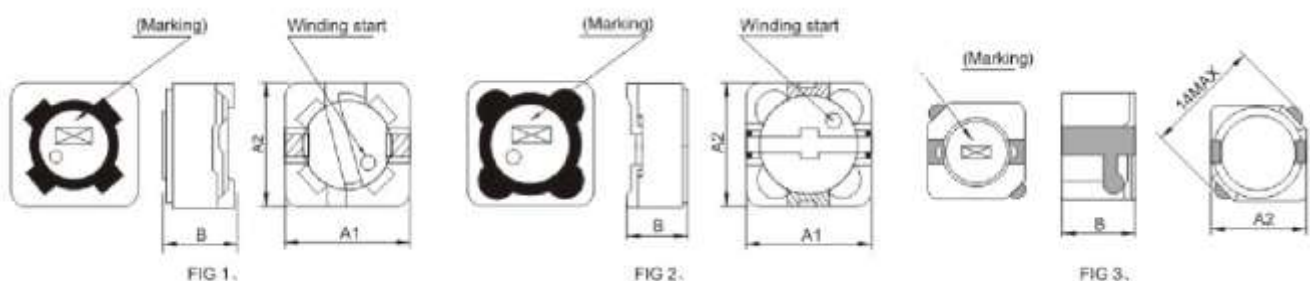

Part Number	Dimensions (mm)			FIG
	A1	A2	B	
SMRH73	7.3±0.3	7.3±0.3	3.8MAX	1
SMRH74	7.3±0.3	7.3±0.3	4.5MAX	1
SMRH124	12.0±0.3	12.0±0.3	5.0MAX	2
SMRH125	12.0±0.3	12.0±0.3	6.2MAX	2
SMRH127	12.0±0.3	12.0±0.3	8.0MAX	2
SMRH104R	10.0±0.3	10.6MAX	4.0MAX	3
SMRH105R	10.0±0.3	10.6MAX	5.0MAX	3
SMRH129	12.0±0.3	12.0±0.3	10.5MAX	2

RECOMMENDED PC BOARD PATTERN

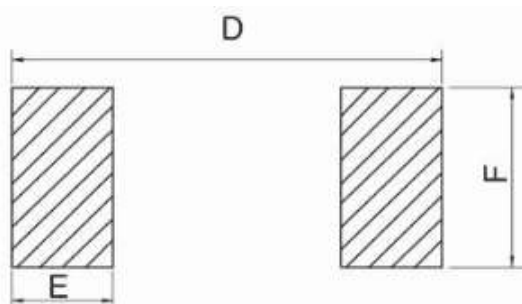

Part Number	Dimensions (mm)		
	D	E	F
SMRH73	8.0	1.8	2.6
SMRH74	8.0	1.8	2.6
SMRH124	13.0	2.4	5.6
SMRH125	13.0	2.4	5.6
SMRH127	13.0	2.4	5.6
SMRH104R	11.0	1.8	3.6
SMRH105R	11.0	1.8	3.6
SMRH129	13.0	2.4	5.6

PRODUCT IDENTIFICATION

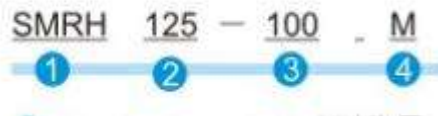

- ① Series name
- ② Dimensions D×T
- ③ Inductance: R47-0.47uH 4R7-4.7uH 100-10uH
- ④ Tolerance: K: ±10% M: ±20% N: ±30%

SPECIFICATIONS

● SMRH73 TYPE

Part Number	Inductance (uH)	Tolerance	Test Frequency (KHz/V)	DCR Max(Ω)	Rated Current Max (mA)
SMRH73-100□	10	K、M、N	1/0.25	0.072	1680
SMRH73-120□	12			0.098	1520
SMRH73-150□	15			0.13	1330
SMRH73-180□	18			0.14	1200
SMRH73-220□	22			0.19	1070
SMRH73-270□	27			0.21	960
SMRH73-330□	33			0.24	910
SMRH73-390□	39			0.32	770
SMRH73-470□	47			0.36	760
SMRH73-560□	56			0.47	680
SMRH73-680□	68			0.52	610
SMRH73-820□	82			0.69	570
SMRH73-101□	100			0.79	500
SMRH73-121□	120			0.89	490
SMRH73-151□	150			1.27	430
SMRH73-181□	180			1.45	390
SMRH73-221□	220			1.65	350
SMRH73-271□	270			2.31	320
SMRH73-331□	330			2.62	280
SMRH73-391□	390			2.94	260
SMRH73-471□	470	4.18	240		
SMRH73-561□	560	4.67	220		



Specifications subject to change without notice. Please check our website for latest information.

Tel: 0086-769-85016697 Fax: 0086-769-85016658 E-Mail: sales@ZXcompo.com www.zxcompo.com

Part Number	Inductance (uH)	Tolerance	Test Frequency (KHz/V)	DCR Max(Ω)	Rated Current Max (mA)
SMRH73-681□	680	K、M	1/0.25	5.73	190
SMRH73-821□	820			6.54	180
SMRH73-102□	1000			9.44	160

Note: When ordering, please specify tolerance code. Tolerance: K: ±10%、M: ±20%、N: ±30%;

1. Operating temperature range -40 -125℃
2. Isat for idncutance drop 30% from its value without current

● SMRH74 TYPE

Part Number	Inductance (uH)	Tolerance	Test Frequency (KHz/V)	DCR Max(Ω)	Rated Current Max (mA)
SMRH74-100□	10	K、M、N	1/0.25	0.075	1840
SMRH74-120□	12			0.100	1710
SMRH74-150□	15			0.105	1470
SMRH74-180□	18			0.120	1310
SMRH74-220□	22			0.150	1230
SMRH74-270□	27			0.180	1120
SMRH74-330□	33			0.200	960
SMRH74-390□	39			0.230	910
SMRH74-470□	47			0.300	880
SMRH74-560□	56			0.350	750
SMRH74-680□	68			0.380	690
SMRH74-820□	82			0.500	610
SMRH74-101□	100			0.610	6000
SMRH74-121□	120			0.660	520
SMRH74-151□	150			0.880	460
SMRH74-181□	180			1.10	420
SMRH74-221□	220			1.45	360
SMRH74-271□	270			2.00	340
SMRH74-331□	330			1.86	320
SMRH74-391□	390			2.85	290
SMRH74-471□	470			3.01	260
SMRH74-561□	560			3.62	230
SMRH74-681□	680			4.63	220
SMRH74-821□	820			5.20	200
SMRH74-102□	1000			6.00	180



Specifications subject to change without notice. Please check our website for latest information.

Tel: 0086-769-85016697 Fax: 0086-769-85016658 E-Mail: sales@ZXcompo.com www.zxcompo.com

Note: When ordering, please specify tolerance code. Tolerance: K: $\pm 10\%$ 、M: $\pm 20\%$ 、N: $\pm 30\%$;

1. Operating temperature range -40 -125°C
2. Isat for idncutance drop 30% from its value without current

● SMRH124 TYPE

Part Number	Inductance (uH)	Tolerance	Test Frequency (KHz/V)	DCR Max(Ω)	Rated Current Max (mA)
SMRH124-1R0□	1.0	K、M、N	1/0.25	0.008	12000
SMRH124-1R5□	1.5			0.010	9300
SMRH124-2R7□	2.7			0.012	8450
SMRH124-3R9□	3.9			0.015	6500
SMRH124-4R7□	4.7			0.018	5700
SMRH124-6R8□	6.8			0.023	4900
SMRH124-8R2□	8.2			0.026	4600
SMRH124-100□	10			0.035	4500
SMRH124-120□	12			0.038	4000
SMRH124-150□	15			0.050	3200
SMRH124-180□	18			0.057	3100
SMRH124-220□	22			0.066	2900
SMRH124-270□	27			0.080	2800
SMRH124-330□	33			0.097	2700
SMRH124-390□	39			0.132	2100
SMRH124-470□	47			0.160	1900
SMRH124-560□	56			0.190	1800
SMRH124-680□	68			0.220	1500
SMRH124-820□	82			0.260	1300
SMRH124-101□	100			0.308	1200
SMRH124-121□	120			0.380	1100
SMRH124-151□	150			0.530	950
SMRH124-181□	180			0.620	850
SMRH124-221□	220			0.700	800
SMRH124-271□	270			0.850	600
SMRH124-331□	330			0.960	500
SMRH124-391□	390			1.15	480
SMRH124-471□	470			1.45	450



Specifications subject to change without notice. Please check our website for latest information.

Tel: 0086-769-85016697 Fax: 0086-769-85016658 E-Mail: sales@ZXcompo.com www.zxcompo.com

Part Number	Inductance (uH)	Tolerance	Test Frequency (KHz/V)	DCR Max(Ω)	Rated Current Max (mA)
SMRH124-561□	560	K、M、N	1/0.25	1.65	430
SMRH124-681□	680			2.10	410
SMRH124-821□	820			2.65	400

Note: When ordering, please specify tolerance code. Tolerance: K: ±10%、M: ±20%、N: ±30%;

1. Operating temperature range -40 -125℃
2. Isat for idncutance drop 30% from its value without current

● SMRH125 TYPE

Part Number	Inductance (uH)	Tolerance	Test Frequency (KHz/V)	DCR Max(Ω)	Rated Current Max (mA)
SMRH125-1R3□	1.3	K、M、N	1/0.25	0.013	7000
SMRH125-2R1□	2.1			0.015	7000
SMRH125-3R1□	3.1			0.022	6000
SMRH125-4R4□	4.4			0.023	5000
SMRH125-5R8□	5.8			0.024	4400
SMRH125-7R5□	7.5			0.028	4200
SMRH125-100□	10			0.030	4000
SMRH125-120□	12			0.032	3500
SMRH125-150□	15			0.035	3300
SMRH125-180□	18			0.055	3000
SMRH125-220□	22			0.060	2800
SMRH125-270□	27			0.070	2300
SMRH125-330□	33			0.080	2100
SMRH125-390□	39			0.090	2000
SMRH125-470□	47			0.120	1800
SMRH125-560□	56			0.135	1700
SMRH125-680□	68			0.145	1500
SMRH125-820□	82			0.175	1400
SMRH125-101□	100			0.185	1300
SMRH125-121□	120			0.250	1100
SMRH125-151□	150	0.290	1000		
SMRH125-181□	180	0.350	900		
SMRH125-221□	220	0.470	800		



Specifications subject to change without notice. Please check our website for latest information.

Tel: 0086-769-85016697 Fax: 0086-769-85016658 E-Mail: sales@ZXcompo.com www.zxcompo.com

Part Number	Inductance (uH)	Tolerance	Test Frequency (KHz/V)	DCR Max(Ω)	Rated Current Max (mA)
SMRH125-271□	270	K、M、N	1/0.25	0.540	750
SMRH125-331□	330			0.740	680
SMRH125-391□	390			0.820	650
SMRH125-471□	470			0.850	580
SMRH125-561□	560			1.000	540
SMRH125-681□	680			1.200	480
SMRH125-821□	820			1.600	430
SMRH125-102□	1000			1.800	400

Note: When ordering, please specify tolerance code. Tolerance: K: ±10%、M: ±20%、N: ±30%;

1. Operating temperature range -40 -125℃
2. Isat for idncutance drop 30% from its value without current

● SMRH127 TYPE

Part Number	Inductance (uH)	Tolerance	Test Frequency (MHz/V)	DCR Max(Ω)	Rated Current Max (mA)
SMRH127-1R2□	1.2	K、M	1/0.25	0.0070	9800
SMRH127-2R4□	2.4			0.0115	8000
SMRH127-3R5□	3.5			0.0135	7500
SMRH127-4R7□	4.7			0.0158	6800
SMRH127-6R1□	6.1			0.0176	6600
SMRH127-7R6□	7.6			0.0200	5900
SMRH127-100□	10			0.0216	5400
SMRH127-120□	12			0.0243	4900
SMRH127-150□	15			0.0270	4500
SMRH127-180□	18			0.0392	3900
SMRH127-220□	22			0.0432	3600
SMRH127-270□	27			0.0459	3400
SMRH127-330□	33			0.0648	300
SMRH127-390□	39			0.0729	2750
SMRH127-470□	47			0.10	2500
SMRH127-560□	56			0.11	2350
SMRH127-680□	68			0.14	2100
SMRH127-820□	82			0.16	1950



Specifications subject to change without notice. Please check our website for latest information.

Tel: 0086-769-85016697 Fax: 0086-769-85016658 E-Mail: sales@ZXcompo.com www.zxcompo.com

Part Number	Inductance (uH)	Tolerance	Test Frequency (MHz/V)	DCR Max(Ω)	Rated Current Max (mA)
SMRH127-101□	100	K、M	1/0.25	0.22	1700
SMRH127-121□	120			0.25	1600
SMRH127-151□	150			0.28	1420
SMRH127-181□	180			0.35	1300
SMRH127-221□	220			0.39	1160
SMRH127-271□	270			0.56	1060
SMRH127-331□	330			0.64	950
SMRH127-391□	390			0.70	880
SMRH127-471□	470			0.98	790
SMRH127-561□	560			1.07	730
SMRH127-681□	680			1.46	670
SMRH127-821□	820			1.64	600
SMRH127-102□	1000			1.84	550

Note: When ordering, please specify tolerance code. Tolerance: K: ±10%、M: ±20%、N: ±30%;

1. Operating temperature range -40 -125℃
2. Isat for idncutance drop 30% from its value without current

● SMRH129 TYPE

Part Number	Inductance (uH)	Tolerance	Test Frequency (MHz/V)	DCR Max(Ω)	Rated Current Max (mA)
SMRH129-1R0□	1.0	N	100/0.25	0.0065	20000
SMRH129-2R7□	2.7	K、M、N	100/0.25	0.0115	16000
SMRH129-4R7□	4.7			0.015	10000
SMRH129-6R8□	6.8			0.020	10000
SMRH129-100□	10			0.025	7000
SMRH129-150□	15			0.036	8000
SMRH129-220□	22			0.030	6500
SMRH129-330□	33			0.0495	3300
SMRH129-390□	39			0.050	3200
SMRH129-470□	47			0.080	3500
SMRH129-680□	68			0.090	2350
SMRH129-101□	100			0.150	5000
SMRH129-221□	220			0.300	1500
SMRH129-561□	560			0.715	800



Specifications subject to change without notice. Please check our website for latest information.

Tel: 0086-769-85016697 Fax: 0086-769-85016658 E-Mail: sales@ZXcompo.com www.zxcompo.com

Part Number	Inductance (uH)	Tolerance	Test Frequency (MHz/V)	DCR Max(Ω)	Rated Current Max (mA)
SMRH129-681□	680	K、M	100/0.25	0.715	1000
SMRH129-122□	1200			1.30	500
SMRH129-332□	3300			5.50	150
SMRH129-103□	10000			15.0	200

Note: When ordering, please specify tolerance code. Tolerance: K: ±10%、M: ±20%、N: ±30%;

1. Operating temperature range -40 -125℃
2. Isat for idncutance drop 30% from its value without current

● SMRH104R TYPE

Part Number	Inductance (uH)	Tolerance	Test Frequency (MHz/V)	DCR Max(Ω)	Rated Current Max (mA)
SMRH104R-1R5□	1.5	K、M、N	100/0.25	0.0081	10000
SMRH104R-2R5□	2.5			0.0105	7500
SMRH104R-3R8□	3.8			0.013	6000
SMRH104R-5R2□	5.2			0.022	5500
SMRH104R-7R0□	7.0			0.027	4800
SMRH104R-100□	10			0.035	4000
SMRH104R-150□	15			0.050	3600
SMRH104R-220□	22			0.073	2900
SMRH104R-330□	33			0.093	2300
SMRH104R-470□	47			0.128	2100
SMRH104R-680□	68			0.213	1500
SMRH104R-101□	100			0.304	1360
SMRH104R-151□	150			0.506	1150
SMRH104R-221□	220			0.756	920
SMRH104R-331□	330			1.090	700

Note: When ordering, please specify tolerance code. Tolerance: K: ±10%、M: ±20%、N: ±30%;

1. Operating temperature range -40 -125℃
2. Isat for idncutance drop 30% from its value without current

● SMRH105R TYPE

Part Number	Inductance (uH)	Tolerance	Test Frequency (MHz/V)	DCR Max(Ω)	Rated Current Max (mA)
SMRH105R-1R5□	1.5	K、M、N	100/0.25	0.0058	10500
SMRH105R-2R2□	2.2			0.0072	9250
SMRH105R-3R3□	3.3			0.0104	7800



Specifications subject to change without notice. Please check our website for latest information.

Tel: 0086-769-85016697 Fax: 0086-769-85016658 E-Mail: sales@ZXcompo.com www.zxcompo.com

Part Number	Inductance (uH)	Tolerance	Test Frequency (MHz/V)	DCR Max(Ω)	Rated Current Max (mA)
SMRH105R-4R7□	4.7	K、M、N	100/0.25	0.0123	6400
SMRH105R-6R8□	6.8			0.0180	5400
SMRH105R-8R2□	8.2			0.0200	4850
SMRH105R-100□	10		1/0.25	0.0260	4450
SMRH105R-150□	15			0.0410	3600
SMRH105R-220□	22			0.0610	2950
SMRH105R-330□	33			0.0840	2400
SMRH105R-470□	47			0.130	2000
SMRH105R-560□	56			0.149	1900
SMRH105R-680□	68			0.201	1650
SMRH105R-820□	82			0.227	1500
SMRH105R-101□	100			0.253	1350
SMRH105R-121□	120			0.303	1280
SMRH105R-151□	150			0.370	1120
SMRH105R-181□	180			0.419	1040
SMRH105R-221□	220			0.500	940
SMRH105R-271□	270			0.627	840
SMRH105R-331□	330			0.812	750
SMRH105R-391□	390			0.953	700
SMRH105R-471□	470			1.289	600
SMRH105R-561□	560			1.60	540
SMRH105R-681□	680			2.00	520
SMRH105R-821□	820			2.15	500
SMRH105R-102□	1000			2.75	480

Note: When ordering, please specify tolerance code. Tolerance: K: ±10%、M: ±20%、N: ±30%;

1. Operating temperature range -40 -125℃
2. Isat for idncutance drop 30% from its value without current



Specifications subject to change without notice. Please check our website for latest information.

Tel: 0086-769-85016697 Fax: 0086-769-85016658 E-Mail: sales@ZXcompo.com www.zxcompo.com

● Packaging Specifications

Tape Dimensions

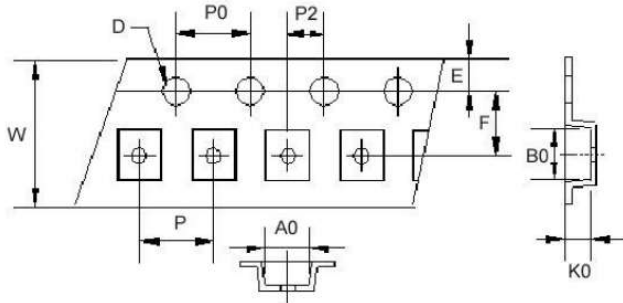

Figure 1

Tape Dimensions

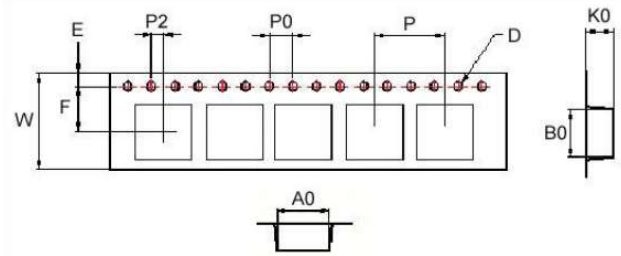

Figure 2

Reel Dimensions

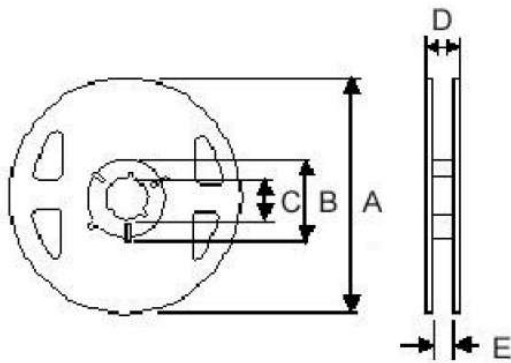

Figure 3

Reel Dimensions

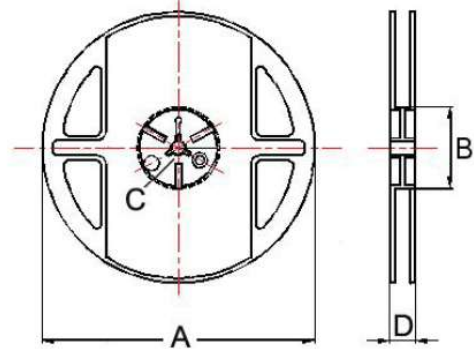

Figure 4